



Broadcast Devices, Inc.

8/16 Passive Switcher

TECHNICAL REFERENCE MANUAL

Broadcast Devices, Inc.
www.broadcast-devices.com

Tel. (914) 737-5032
Fax. (914) 736-6916

REV: C 7/13

Table of Contents

I. Introduction	3
II. Specifications	3
III. Installation	4-5
IV. Warranty	6
V. Schematic Diagrams	7-9

I. Introduction

The 8/16 Switcher series are an 8 or 16 input, 2 by 1 passive switchers. The 8/16 series are capable of accepting up to two or four sets of balanced inputs and switching them to a single or dual set of up to 8 outputs. The signal path is completely passive using latching relays. Front panel and remote control of the unit is possible. Local status is provided by lights on the front panel and remote status is provided via dry contact closure on the remote control connector. The unit requires only a momentary connection to ground on the appropriate pin for switcher operation.

A. Unpacking and Inspection

Carefully unpack the unit after receipt and inspect for damage that may have occurred during shipping. If damage is noted, contact the shipper immediately and file a damage claim. The contents of the package have been insured to cover total replacement cost. Make certain that the package contents are the same as noted on the packing slip. If not, contact Broadcast Devices, Inc. Check to make sure all mechanical parts are secure.

B. General Description

The 8/16 series switchers can accept as many as two sets of 8 or 16 monaural balanced inputs which can be selected to a single or dual set of 8 outputs. By use of a simple microprocessor unit the control functions of the unit can be made to be momentary or maintained closure for command. In addition there is provision for configuring the unit for power loss position memory or not. The signal path is completely passive.

The front panel has two momentary lighted pushbutton switches. They provide local control and status of the 8/16 Switcher.

II. Specifications

Input Connectors:	DB25 Female
Output Connector:	DB25 Female
Remote Control Connector:	DB25 Female
Status:	Dry Contact NC/C/NO for position
Number of A/B inputs:	8 balanced for 8 Channel unit 16 for 16 channel unit
Power Requirements:	100 - 240 Volts A.C. 50 - 60 Hertz
Operating Temperature Range:	0 - 60° Celsius non condensing atmosphere
Physical Dimensions:	1.75 H X 19 W X 10 D (inches)
Shipping Weight:	14 lbs.

III. Installation

A. Initial Configuration

The unit as configured from the factory is set to accept 100 to 240 Volts A.C. 50 - 60 Hertz electrical power. No changes are necessary to change voltage selection.

B. Location and Hookup Considerations

Locate the 8/16 in a 19-inch E.I.A. standard rack enclosure in close proximity to the equipment that it is going to interface between. Allow sufficient airflow space between equipment to allow for proper cooling. Make all desired input and output connections to your external equipment using the pin out provided for the DB25 connectors. Optional DB25 to XLR breakout panels are available from bdi. The audio connector pin assignments which can be found in the schematics section of this manual conform to the Tascam A-DAT™ format. This is a commonly used worldwide standard for which cable assemblies are available from multiple sources including BDI. Call us for more information about availability and pricing.

Always make sure that the 8/16 is plugged in to a properly grounded A.C. receptacle. A common practice to break ground loops is to isolate the chassis from electrical ground. **THIS IS NOT RECOMMENDED AND WILL VOID THE WARRANTY IF DONE IN THE FIELD.** An alternate method to break ground loops is to break the signal grounds on one side of the equipment.

C. Remote Control/Status Connection

Refer to the table on the following page for remote control and status connections. The 8/16 requires a momentary ground closure for switching operation in its factory default mode. The 8/16 can accept an open collector output for this purpose or a simple relay closure will actuate a switching function. Status provided is a set of dry contacts offering NO/C/NC connection to remote control equipment.

D. Optional User Features

i. Maintained Switch Closure Operation Instructions:

The 8/16 Switcher can be configured to require a maintained remote closure to hold the B position. In this configuration a maintained remote control closure is necessary to keep the switcher in the B position. To place the 8/16 in this mode connect pin 8 of J2 Remote Control/Status connector to common such as pin 17. To command the 8/16 into the B position connect a switch closure from J2 Remote Control/Status connector pin 9 to common such as pin 18. As long as the connection between pin 9 and to any of the common pins 17-20 the unit will remain in the B position. To command to the A position the connection between pin 9 and common is broken.

ii. Power Loss Memory

When the 8/16 is configured for momentary closure to command from A to B or B to A input (factory default), the 8/16 can be configured to default to the last channel selected upon power up or can be configured to default to the A position upon power up. Factory default is for the 8/16 to remember last channel selected upon power up. If it is desired for the unit to always default to position A upon power up remove the top cover and locate JP3 on the main PC board. The jumper should be installed connecting the two pins together. Check the operation of the unit after installing the jumper and then replace the top cover.

Remote Control Status Table

Pin 1 K36 COM

Pin 2 K36 NO

Pin 3 K37 NC

Pin 4 No Connection

Pin 5 No Connection

Pin 6 No Connection

Pin 7 No Connection

Pin 8 Select A Command – Momentary to ground

Pin 9 Select B Command – Momentary to ground

Pin 10 POS A Status – connected to common when A selected

Pin 11 POS B Status – connected to common when B selected

Pin 12 No Connection

Pin 13 No Connection

Pin 14 K36 NC

Pin 15 K37 COM

Pin 16 K37 NO

Pin 17 GND

Pin 18 GND

Pin 19 GND

Pin 20 GND

Pin 21 GND

Pin 22 GND

Pin 23 + 5VDC

Pin 24 + 5VDC

Pin 25 No Connection

IV. Warranty

Broadcast Devices, Inc. products are warranted against failure due to faulty materials or workmanship for a period of one year from the date of shipment to the ultimate user. The warranty covers repair or replacement of defective parts at the factory, provided the unit has been returned prepaid by the user. All shipments to the factory shall have affixed to the outside of the container an R. A. number obtained from the factory. The above warranty is void if the unit has been modified by the user outside of any recommendations from the factory or if the unit has been abused or operated outside of its electrical or environmental specifications. If customer conducted field tests suggest that the unit may be faulty, whether or not the unit is in warranty, a full report of the difficulty should be sent to Broadcast Devices, Inc. factory. The office may suggest further tests or authorize return for factory evaluation. Units sent to the factory should be well packed and shipped to Broadcast Devices, Inc. – Check our web site for shipping address at www.broadcast-devices.com. Remember to affix the R.A. number to the outside of the carton. Any packages received without such R.A. number will be refused. Note: freight collect shipments will also be refused. When the unit has been received, inspected and tested, the customer will receive a report of the findings along with a quotation for recommended repairs, which are found falling outside of the standard warranty. Units returned for in-warranty repairs which are found not to be defective will be subject to an evaluation and handling charge. In warranty units will be repaired at no charge and returned via prepaid freight. Out-of-warranty units needing repair require a purchase order and will be invoiced for parts, labor, and shipping charges. When ordering replacement part, always specify A) Part number or Description, and Quantity; B) Date of Purchase, Where Purchased; C) Any Special Shipping Instructions. Always specify a street address, as shipping companies cannot deliver to a postal box.

Broadcast Devices, Inc. is not responsible for any other manufacturer's warranty on original equipment. Nor are we responsible for any failure, damage, or loss of property that may occur due to the installation or operation of our equipment outside of recommended specifications.

Broadcast Devices, Inc. reserves the right to make changes to specifications and materials without prior notice.

V. Schematic Diagrams

A. Schematic Diagrams

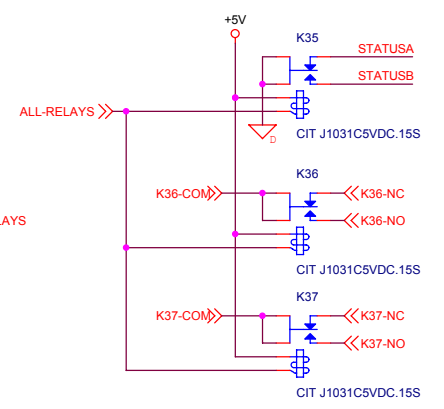
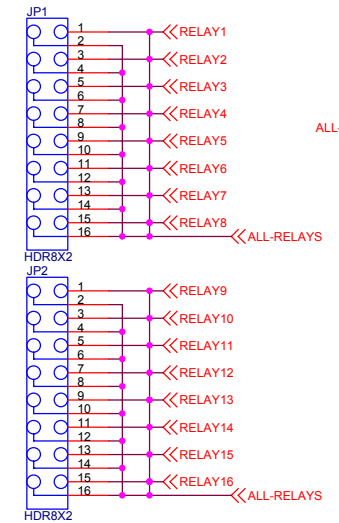
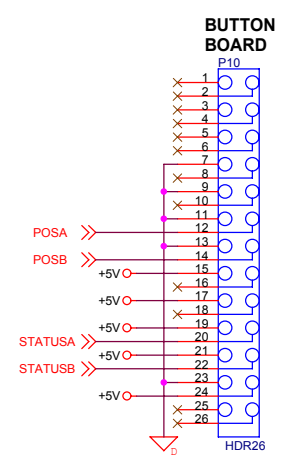
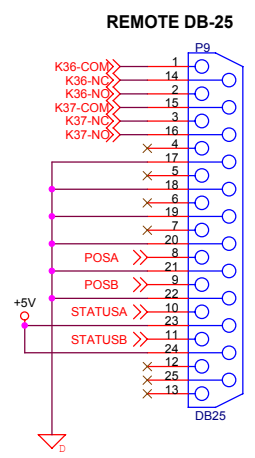
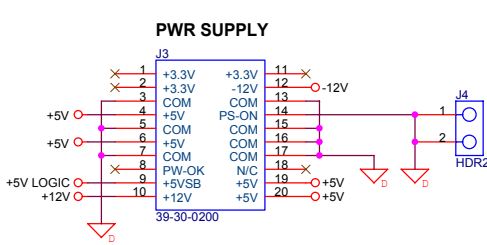
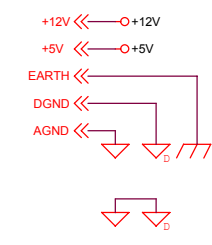
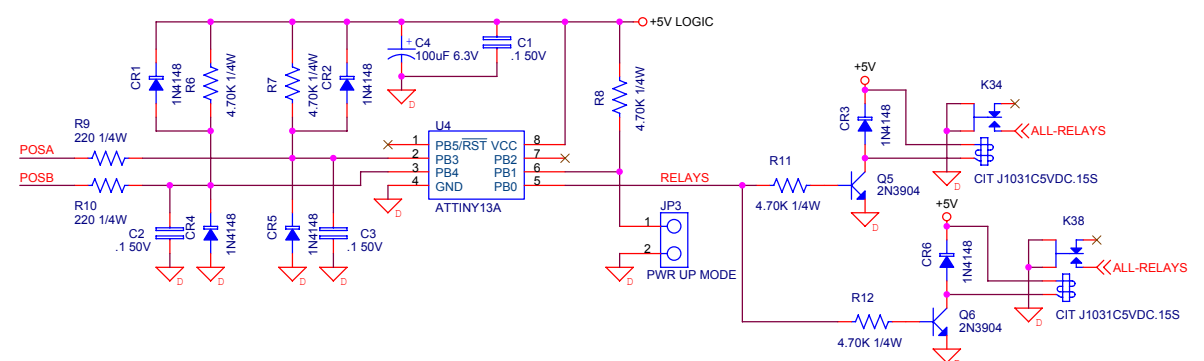

Broadcast Devices, Inc.		
Title 8/16 SWITCHER CONTROL		
Size B	Document Number	Rev C
Date: Monday, July 22, 2013	Sheet 1	of 3

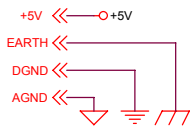
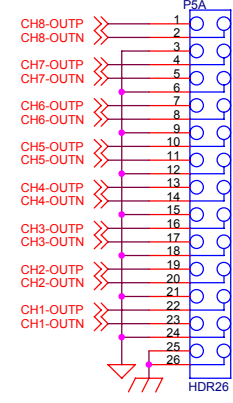
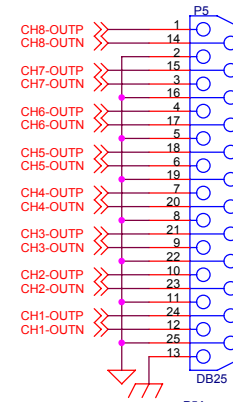
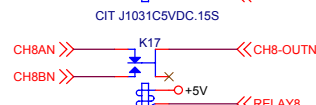
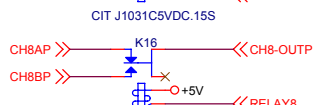
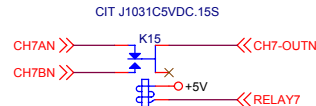
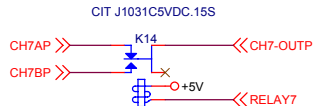
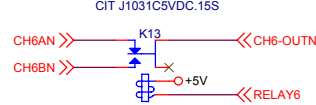
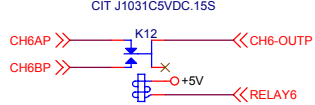
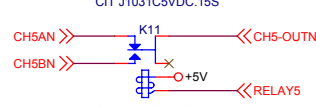
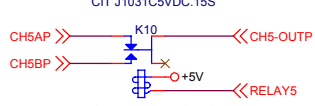
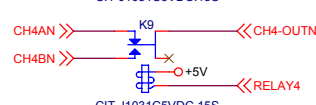
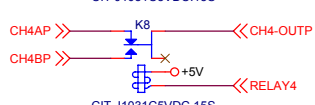
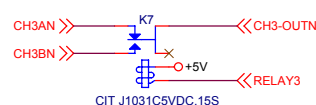
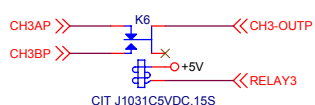
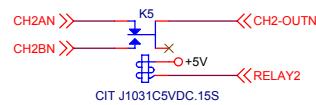
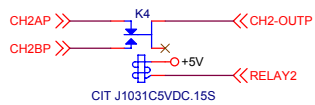
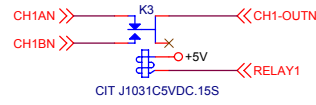
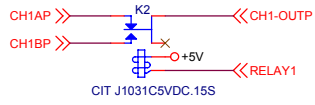
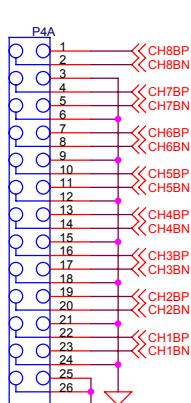
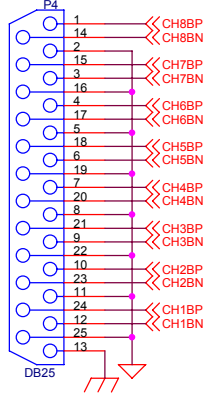
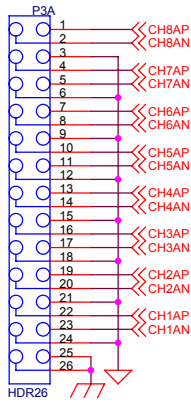
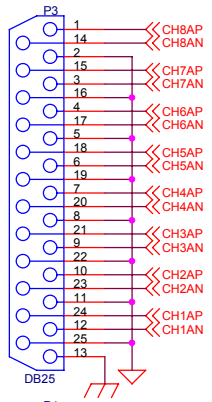

Broadcast Devices, Inc.		
Title 8/16 SWITCHER CHAN 1-8		
Size B	Document Number	Rev C
Date: Monday, July 22, 2013	Sheet 2	of 3

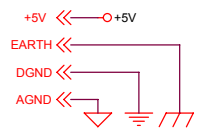
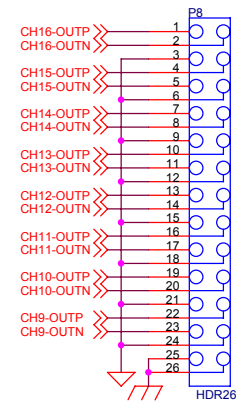
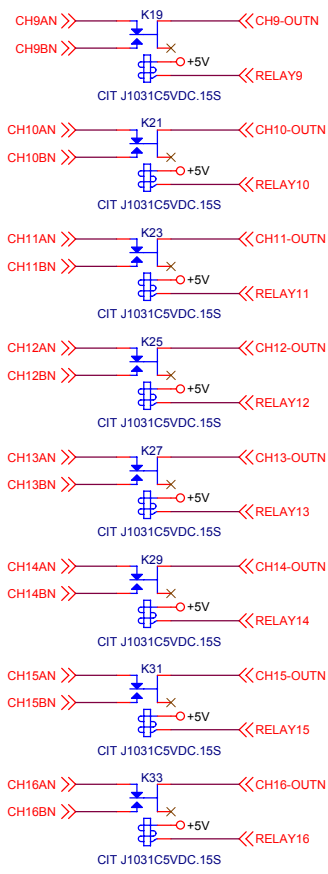
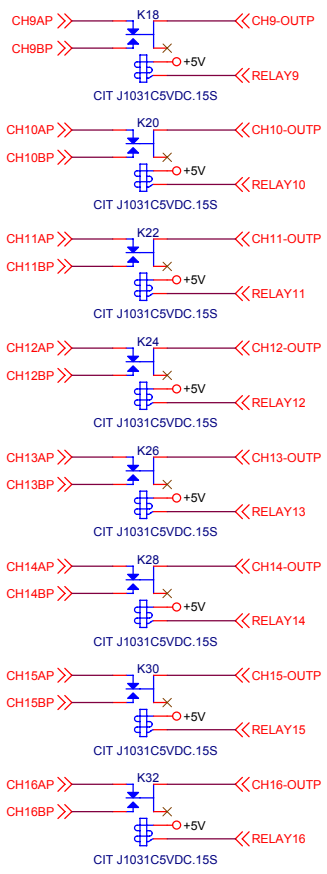
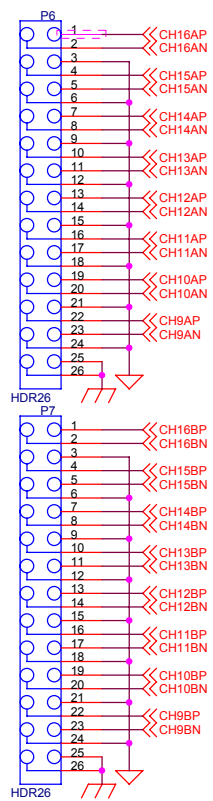

Broadcast Devices, Inc.		
Title 8/16 SWITCHER CHAN 9-16		
Size B	Document Number	Rev C
Date:	Monday, July 22, 2013	Sheet 3 of 3